

kdl*n*

ASSEMBLY INSTRUCTIONS
ISTRUZIONI DI MONTAGGIO
INSTRUCCIONES DE MONTAJE
MONTAGE-ANLEITUNG
INSTRUCCIONES DE MONTAJE
ИНСТРУКЦИИ ПО МОНТАЖУ

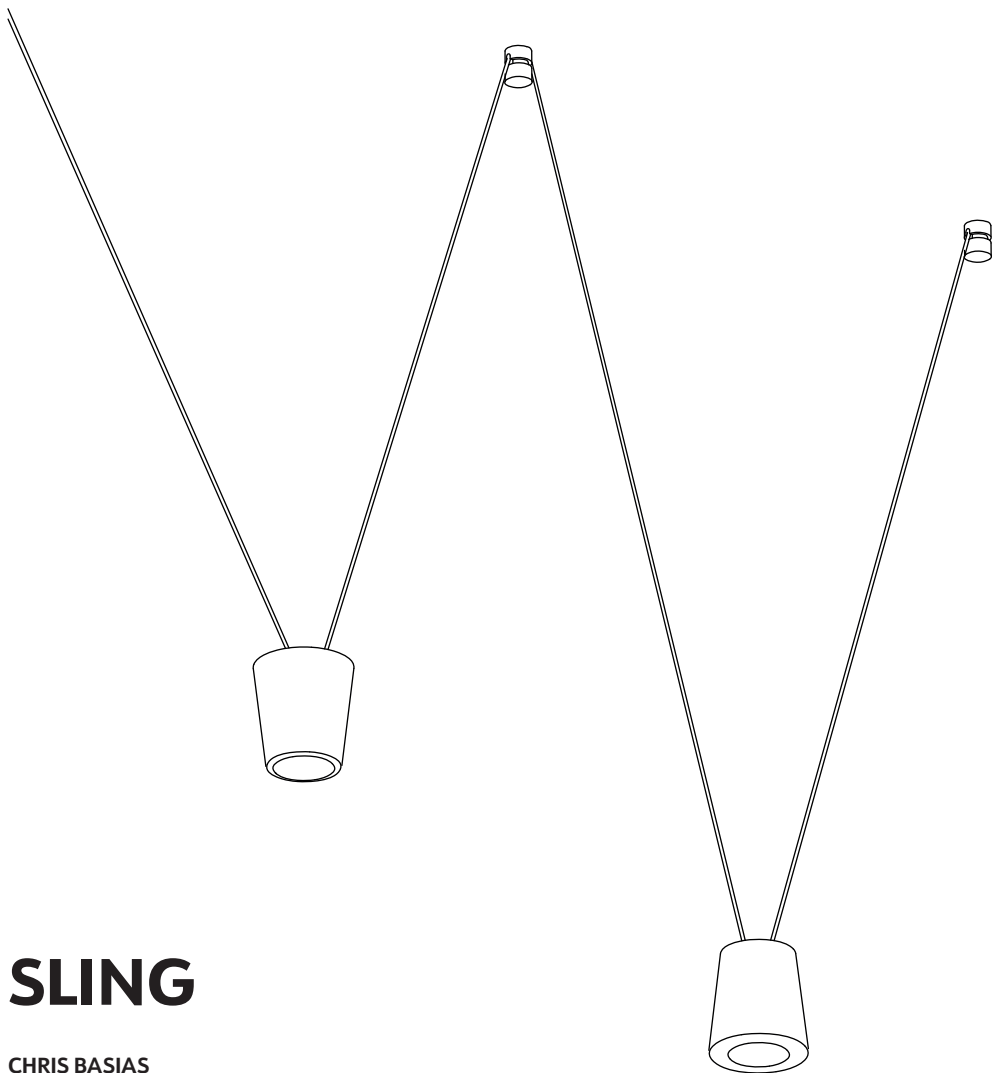

SLING

CHRIS BASIAS

WARNING

The safety is guaranteed by the appropriate use of the following instructions, so you must keep them.

Always disconnect the main voltage before working on the appliance.

Never use abrasive products or aggressive detergents for cleaning the lamp.

Kdln will not provide a replacement until the nature of defect has been determined.

The symbol  indicates that the product must be thrown out in a different manner than with the urban trash.

ATTENZIONE

La sicurezza dell'apparecchio è garantita con l'uso appropriato delle seguenti istruzioni, pertanto è necessario conservarle.

Togliere sempre la tensione prima di operare sull'apparecchio.

Per pulire la lampada non usare mai prodotti abrasivi o detergenti aggressivi.

Kdln non effettuerà nessuna sostituzione se non dopo aver accertato la natura del difetto.

Il simbolo  indica che il prodotto deve essere smaltito in modo differenziato dai rifiuti urbani.

ATTENTION

La sûreté de l'appareil n'est garantie qu'en suivant scrupuleusement les instructions ci-après.

Il est donc nécessaire de les conserver.

Isoler l'appareil du secteur avant toute manipulation.

Pour nettoyer la lampe, ne jamais utiliser de produits abrasifs ou de nettoyeurs agressifs.

Kdln ne remplacera aucun appareil sans en avoir pu vérifier le défaut.

Le symbole  indique que le produit doit être éliminé d'une autre façon que celle avec les déchets urbains.

ACHTUNG

Die Sicherheit dieses Artikels wird nur durch die strikte Befolgung der nachfolgenden Betriebsanleitung gewährleistet.

Bitte heben Sie diese unbedingt auf.

Vor allen Arbeiten ziehen Sie bitte den Stecker aus der Dose.

Für die Reinigung der Lampe niemals Schleifmittel oder aggressive Reinigungsmittel verwenden

Kdln leistet grundsätzlich erst nach einer gründlichen Überprüfung Ersatz.

Das Symbol  zeigt an, dass das Produkt getrennt vom Stadtmüll entsorgt werden muss.

ATENCIÓN

La seguridad del aparato está garantizada sólo con el uso apropiado de las instrucciones siguientes,

por lo tanto es necesario atenderlas puntualmente.

Desconectar siempre la alimentación antes de trabajar en el aparato.

Nunca utilice productos abrasivos o detergentes agresivos para limpiar la lámpara.

Kdln no efectuará sustitución alguna hasta después de haber verificado la naturaleza del defecto.

El símbolo  indica que el producto debe ser eliminado en modo diferenciado del resto de los desechos urbanos.

ВНИМАНИЕ!

Безопасность прибора обеспечивается за счет правильного пользования настоящими инструкциями, поэтому необходимо их сохранять.

Перед началом работы на приборе всегда отключать напряжение.

Для очистки лампы не использовать абразивные продукты или агрессивные чистящие средства.

Kdln не выполняет никаких замен, если не было установлено происхождение дефекта.

Символ  указывает на то что данная продукция должна быть переработана отдельно от городских отходов.



IP20



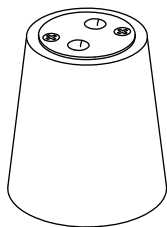

1 x

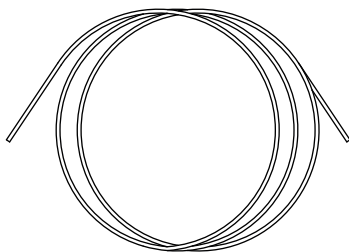

4 m

BOX N.1

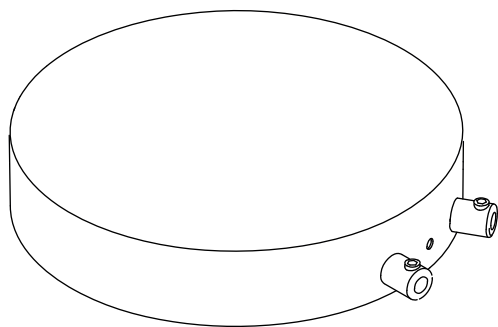

4 x

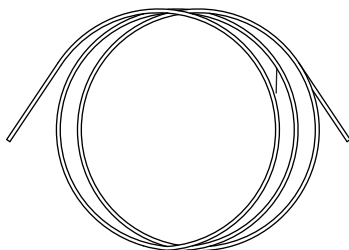

10 m

BOX N.2

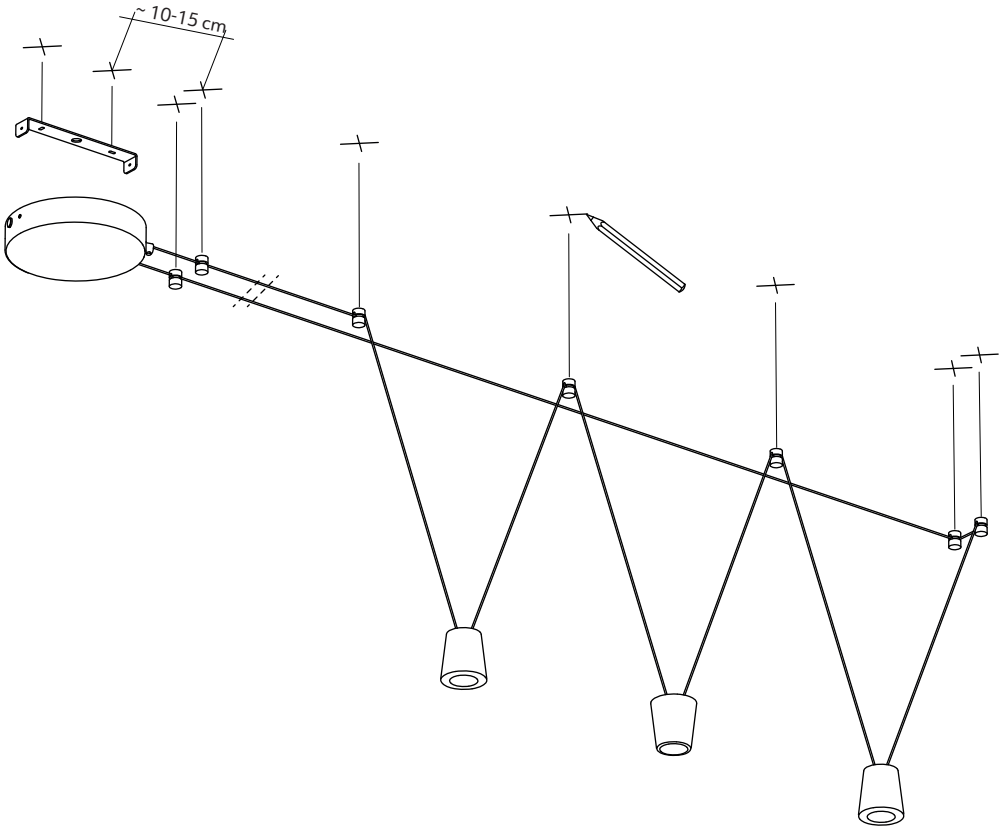
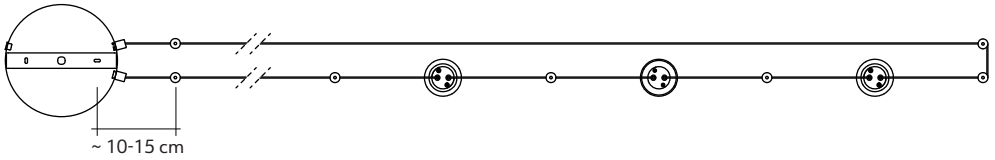

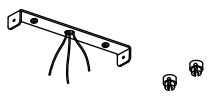
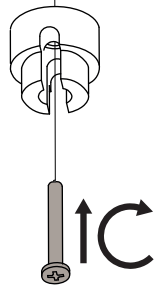
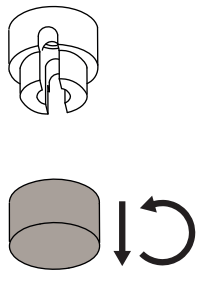
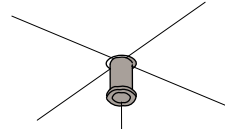
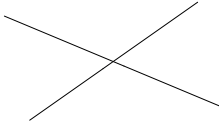
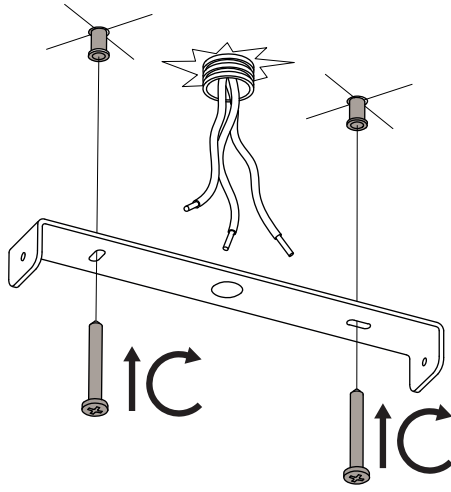

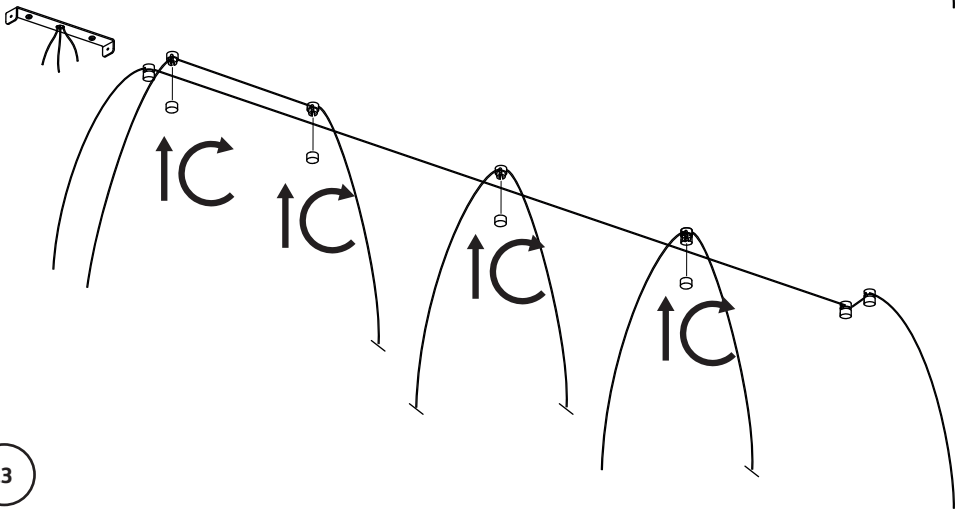
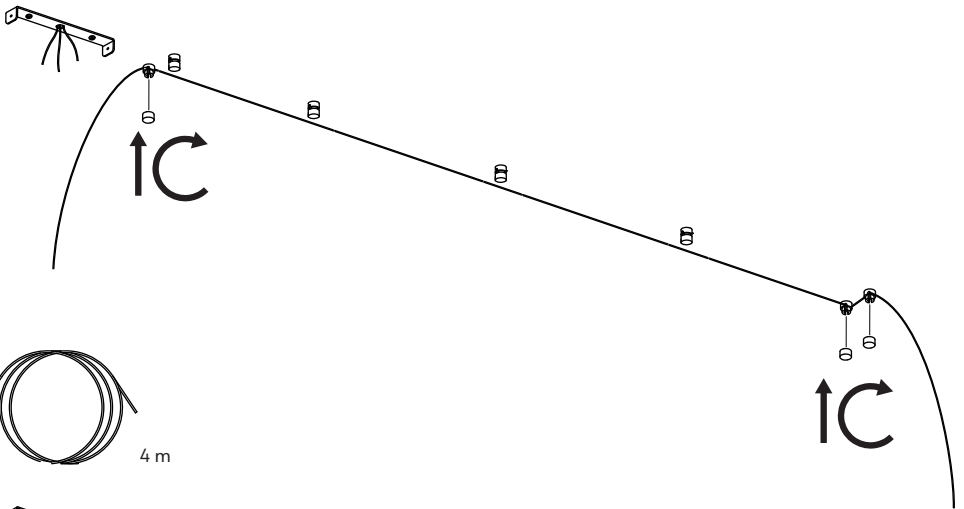
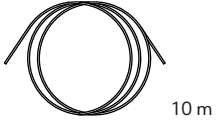
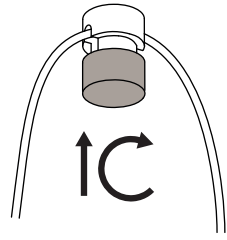
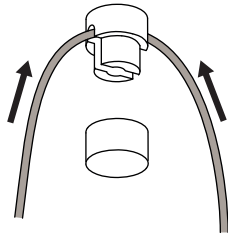

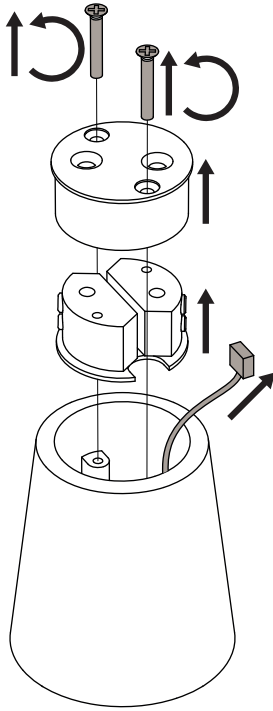

4

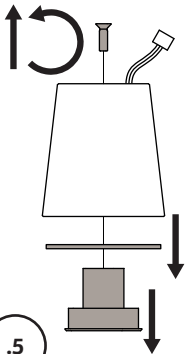
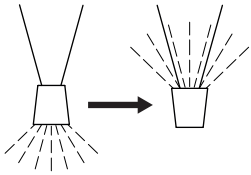

5

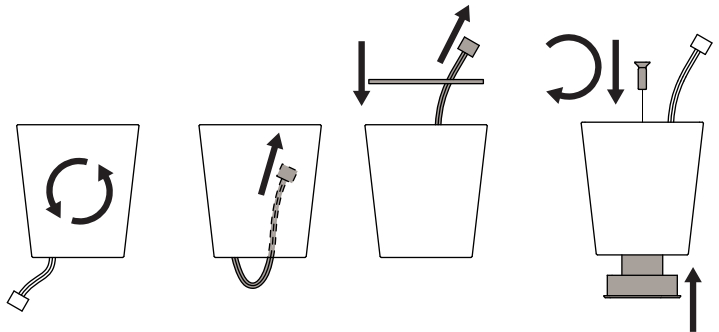

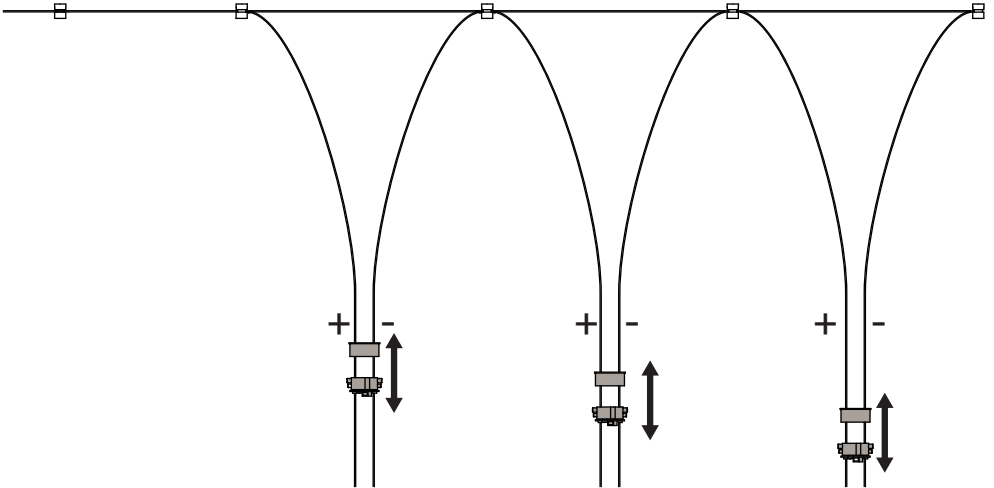
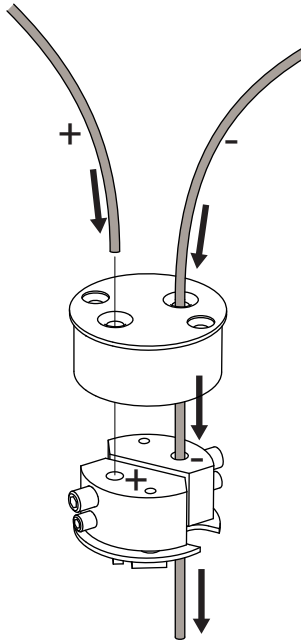

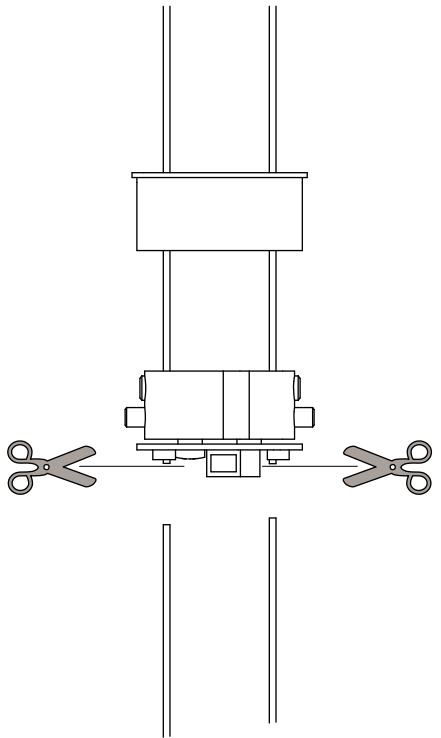
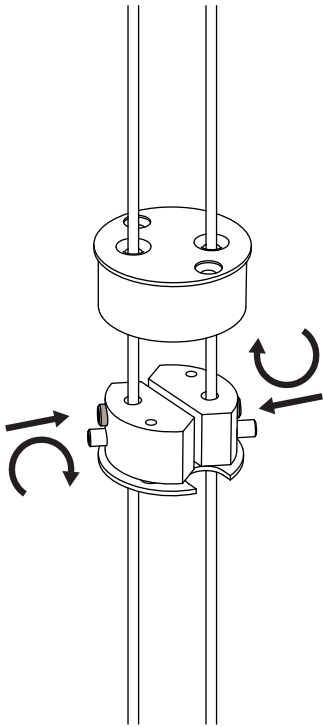

.7

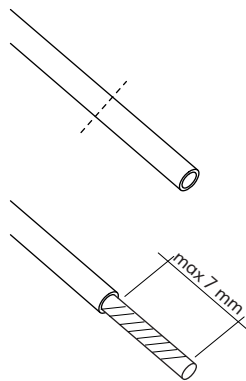
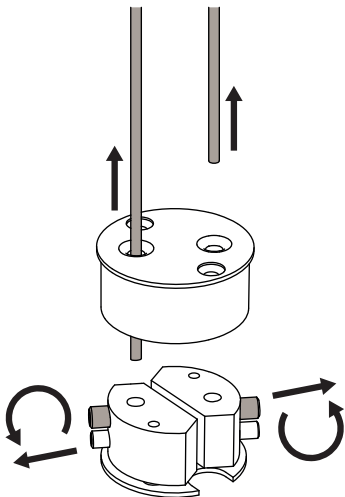

.8

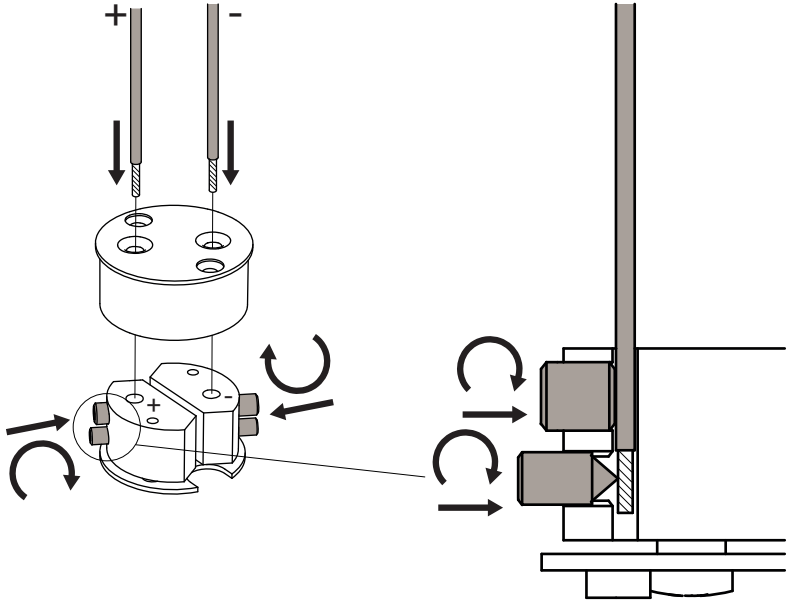

.9

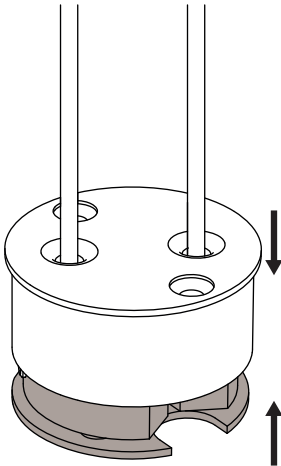

.10

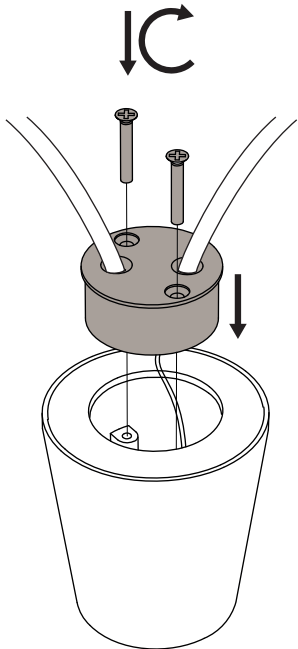
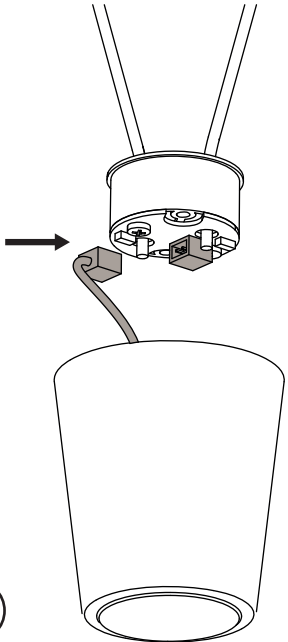
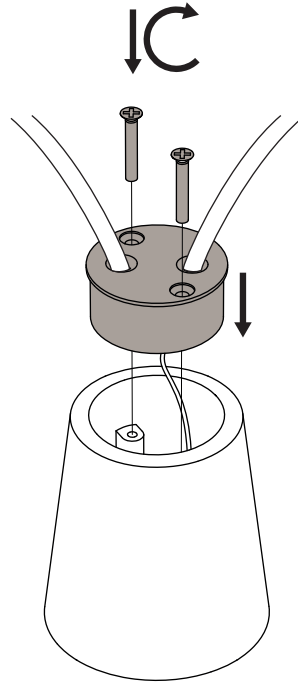
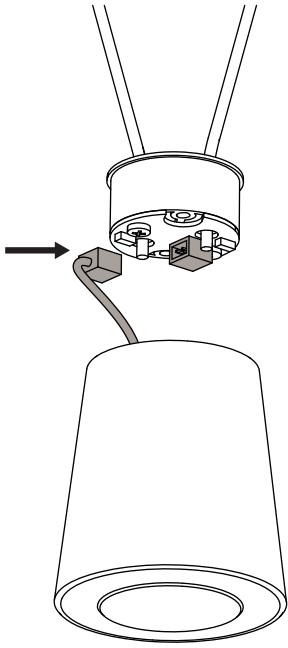

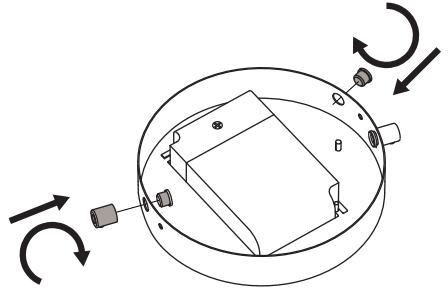
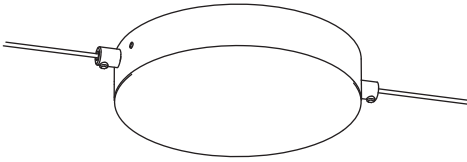
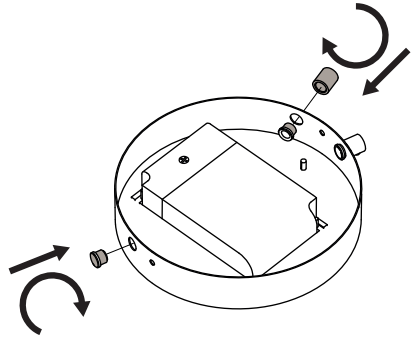
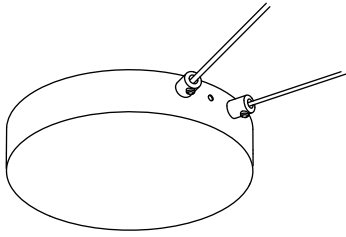

.12

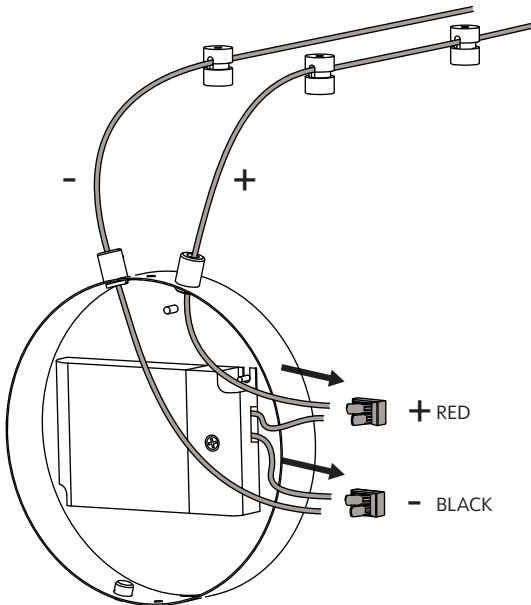

.13

ON-OFF wiring diagram

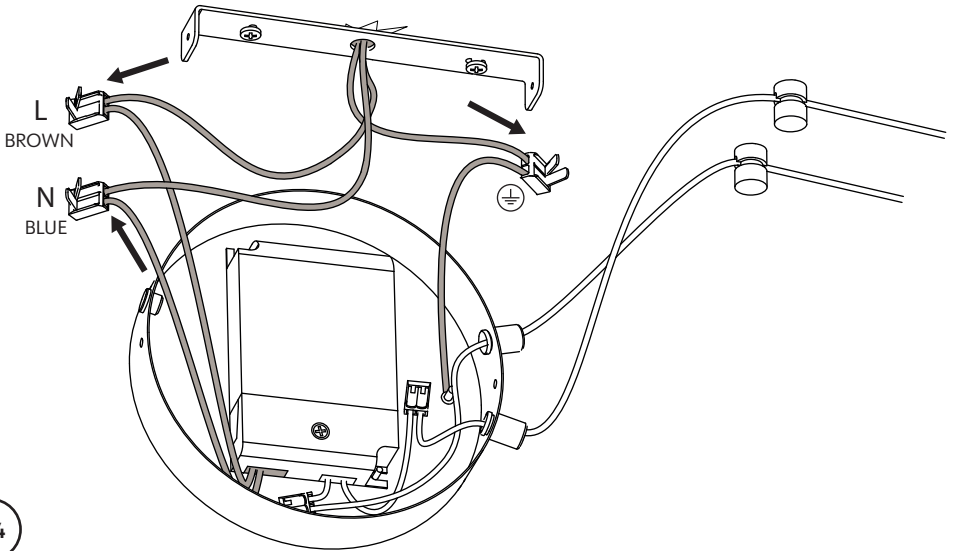

.14

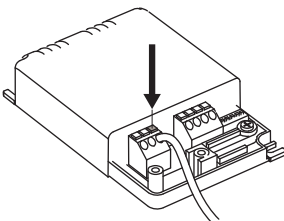
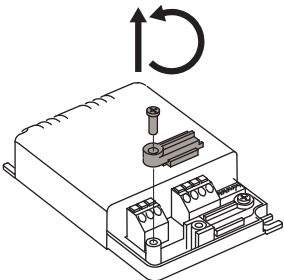
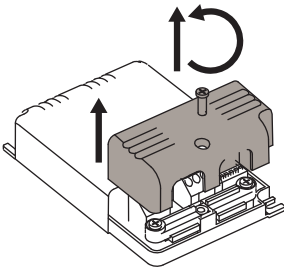

.15

PUSH DIMM wiring diagram

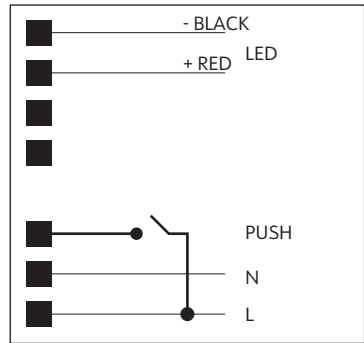

1-10 V DIMM wiring diagram

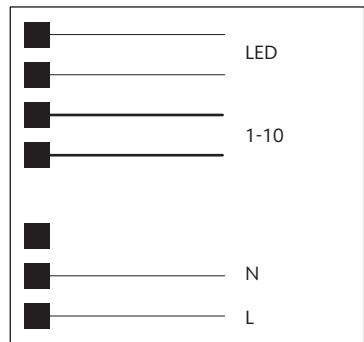

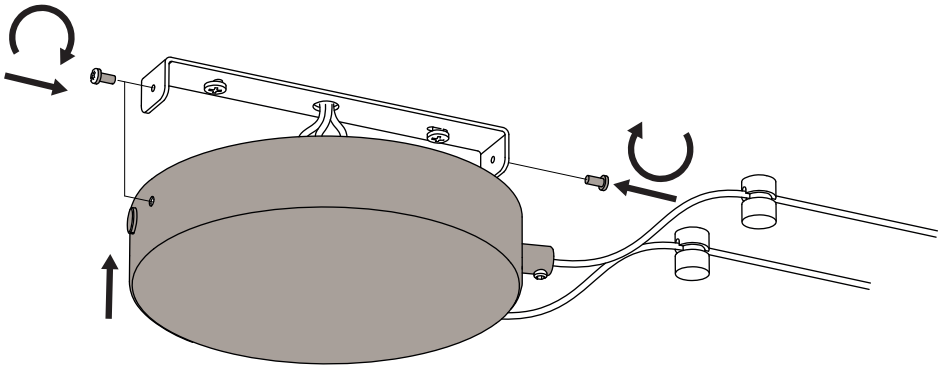

.16

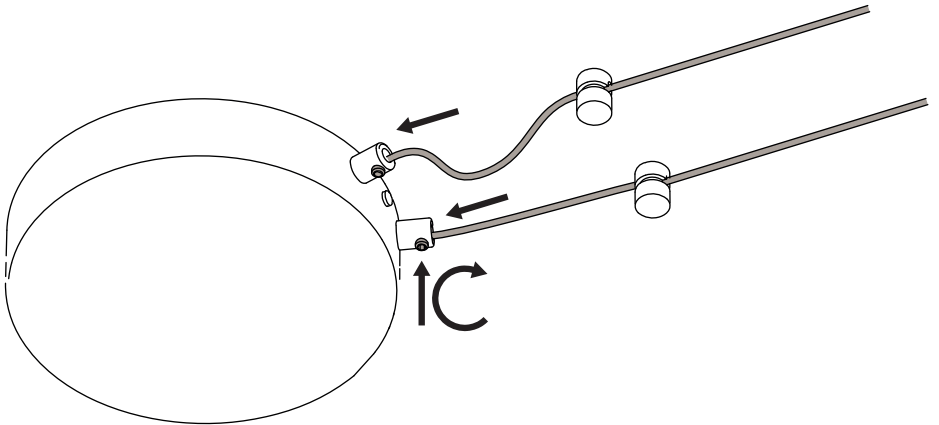

.17

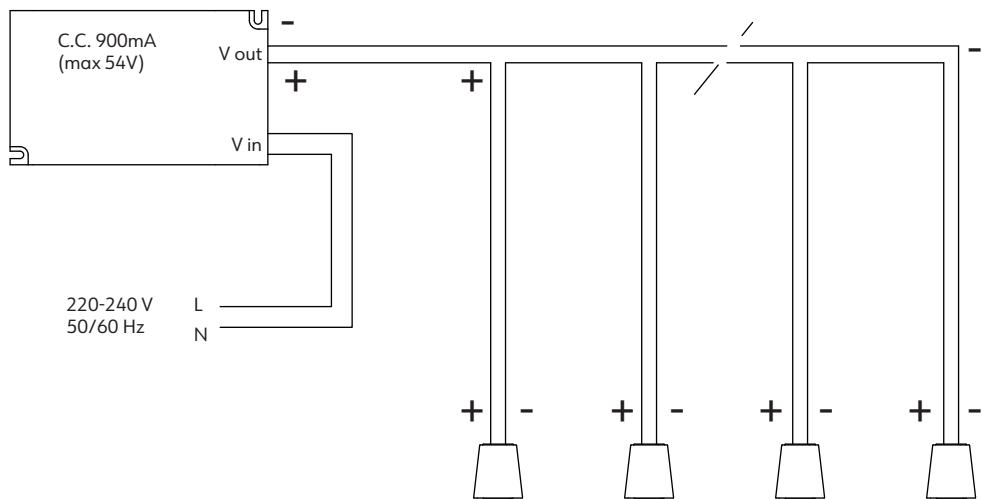

.18

Spot quantity	Forward Voltage	Current	MAX cable length
2	11.5 V	900 mA	100 m
3	17.1 V	900 mA	100 m
4	22.8 V	900 mA	100 m
5	25.8 V	900 mA	100 m
6	34.2 V	900 mA	80 m
7	39.9 V	900 mA	65 m
8	45.6 V	900 mA	55 m
9	51.3 V	900 mA	46 m

.19

BULBS, LAMPADINE, AMPOULES, LEUCHTENMITTEL, BOMBILLAS, ТИП ЛАМПОЧКИ
board LED max 9 x 5W

FEEDING, ALIMENTAZIONE, ALIMENTATION, SPANNUNG, TENSION DE RED, НАПРЯЖЕНИЕ
220-240 V - 50/60 Hz

